

# Galaxies, Cosmology and Dark Matter

---



Lecture given by  
Ralf Bender  
USM

Script by:  
Christine Botzler, Armin Gabasch,  
Georg Feulner, Jan Snigula

Summer semester 2000

# Chapter 11

# Gravitational Lensing

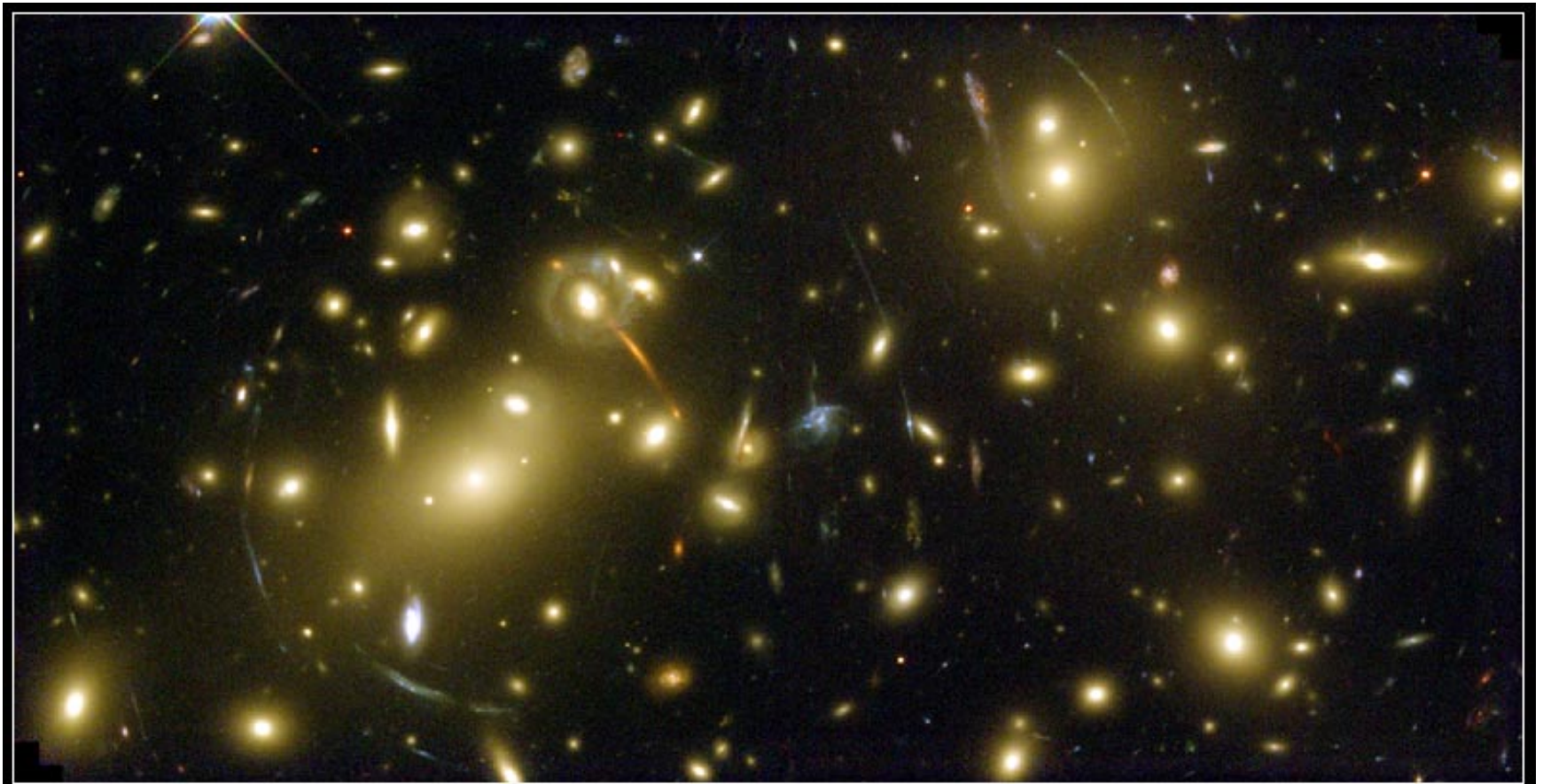

**Galaxy Cluster Abell 2218**

**HST • WFPC2**

NASA, A. Fruchter and the ERO Team (STScI, ST-ECF) • STScI-PRC00-08



Galaxy Cluster Abell 370  
(VLT UT1 + FORS1)

ESO PR Photo 47c/98 ( 26 November 1998 )

© European Southern Observatory



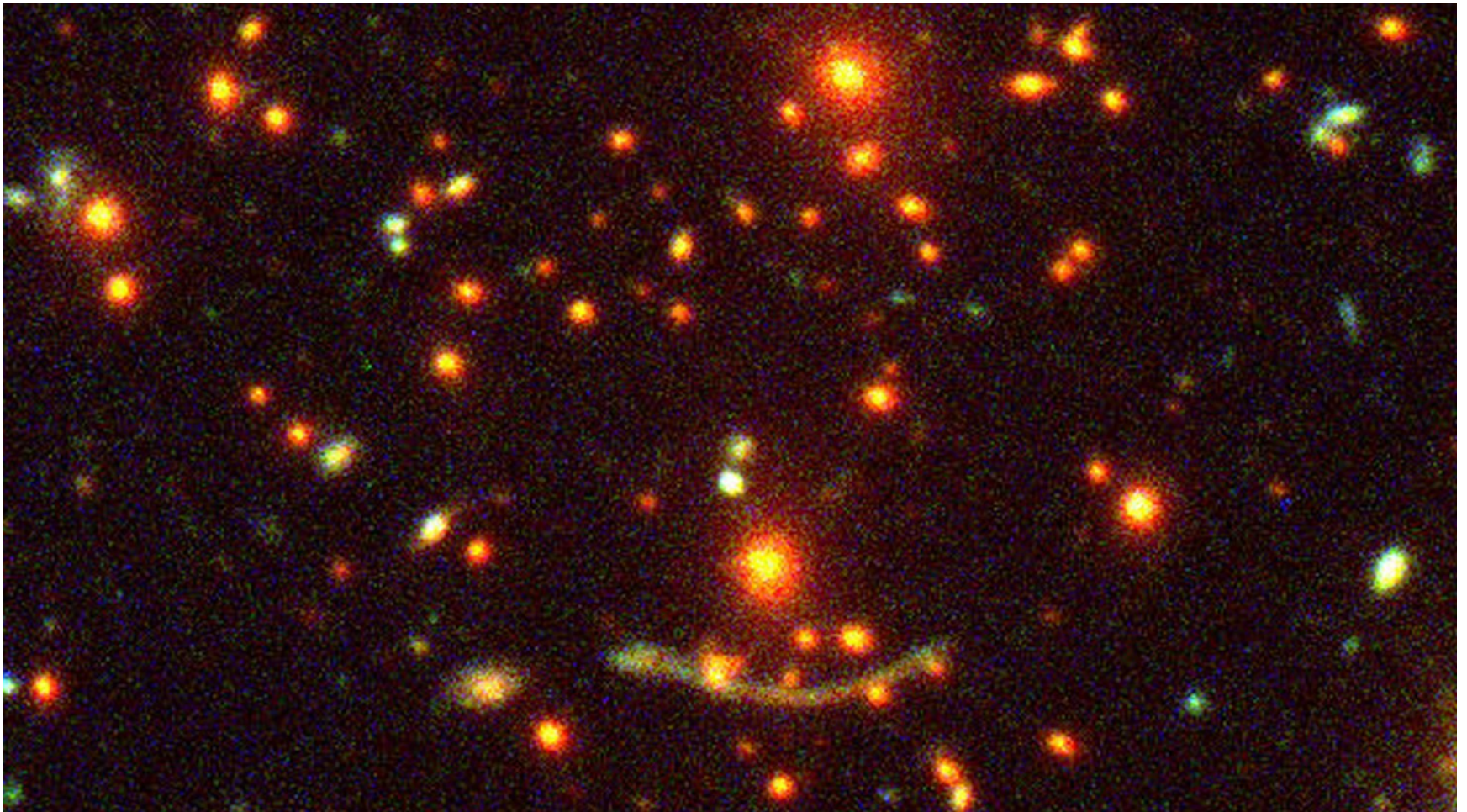



**Gravitationally Lensed Image of Highest Redshift Galaxy**

PRC97-25 • ST ScI OPO • July 30, 1997

M. Franx (Kapteyn Astronomical Institute), G. Illingworth (Lick Observatory) and NASA

HST  
WFPC2

## 11.1 Basics of Gravitational Lensing

One consequence of Einstein's Theory of Relativity is that light rays are deflected by gravity. Einstein calculated the magnitude of the deflection that is caused by the sun. Since the potential and the velocity of the deflecting mass are small ( $v \ll c$  and  $\Phi \ll c^2$ ) the deviation angle is expected to be small as well. According to Einstein's formula, a light ray passing the surface of the Sun tangentially is deflected by  $1.7''$ . This deflection angle has in the mean time been confirmed with a very high accuracy (0.1 %).

For further information see also:

- R. Narayan, M. Bartelmann: Lectures on Gravitational Lensing; in:  
*Formation of Structure in the Universe*  
Edited by Avishai Dekel and Jeremiah P. Ostriker. Cambridge:  
Cambridge University Press, 1999., p.360
- Schneider, Ehlers, Falco: Gravitational Lenses  
Springer Verlag

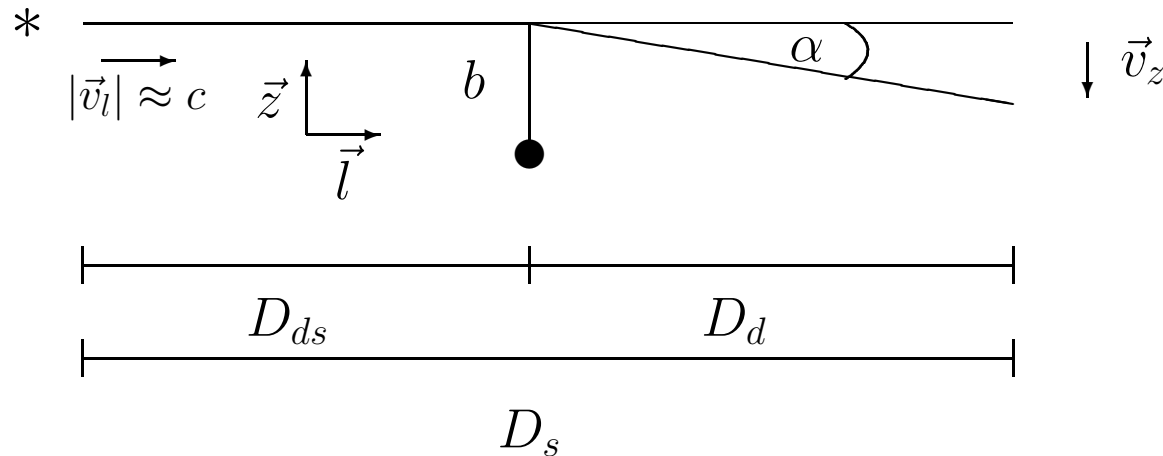

The light path from the source to the observer can then be broken up into three distinct zones:

1. Light travels from the source to a point close to the lens through unperturbed spacetime, since  $b \ll D_d$ .
2. Near the lens the light is deflected.
3. Light travels to the observer through unperturbed spacetime, since  $b \ll D_{ds}$ .



In a naive Newtonian approximation one would derive:

$$\alpha = \frac{v_z}{c} = \frac{1}{c} \int \underbrace{\frac{d\Phi}{dz}}_* dt = \frac{1}{c^2} \int \frac{d\Phi}{dz} dl$$

\*: acceleration in z direction; because the acceleration doesn't depend on the energy of the photons, gravitational lenses are achromatic.

This result differs only by a factor of two from the correct general relativistic result:

$$\vec{\alpha} = \frac{2}{c^2} \int \vec{\nabla}_{\perp} \Phi dl \quad \text{G.R.}$$

where the deflection angle  $\alpha$ , written as vector  $\vec{\alpha}$  perpendicular to the light propagation  $\vec{l}$ , is the integral of the potential gradient perpendicular to the light propagation.

For a point mass the potential can be written as:

$$\Phi(l, z) = \frac{-GM}{(l^2 + z^2)^{1/2}}$$

Therefore:

$$\frac{d\Phi}{dz} = \frac{+GMz}{(l^2 + z^2)^{3/2}} \quad (= \vec{\nabla}_{\perp}\Phi)$$

After integration:

$$\alpha = \frac{2}{c^2} \int_{-\infty}^{+\infty} \frac{GMz}{(l^2 + z^2)^{3/2}} dl = \frac{4GMz}{c^2} \int_0^{+\infty} \frac{dl}{(l^2 + z^2)^{3/2}} = \frac{4GMz}{c^2} \left[ \frac{l}{z^2(l^2 + z^2)^{1/2}} \right]_0^{+\infty}$$

Thus the deflection angle  $\alpha$  for a light ray with impact parameter  $b = z$  near the point mass  $M$  becomes:

$$\alpha = \frac{4GM}{c^2 b} = \frac{2R_S}{b}$$

where  $R_S = \frac{2GM}{c^2}$  is the **Schwarzschild radius** of the mass  $M$ , i.e. the radius of the black hole belonging to the mass  $M$ .

Therefore for the sun ( $M_{\odot} \simeq 2 \cdot 10^{33} g \Rightarrow R_S \simeq 3.0 km$ ) we get a deflection angle  $\alpha$  at the Radius of the sun ( $\simeq 700000km$ ) of:

$$\alpha_{\odot, R_{\odot}} \simeq 1.7''$$

In order to calculate the deflection angle  $\alpha$  caused by an arbitrary mass distribution (e.g. a galaxy cluster) we use the fact that the extent of the mass distribution is very small compared to the distances between source, lens and observer:

$$\Delta l \ll D_{ds} \text{ and } \Delta l \ll D_d$$

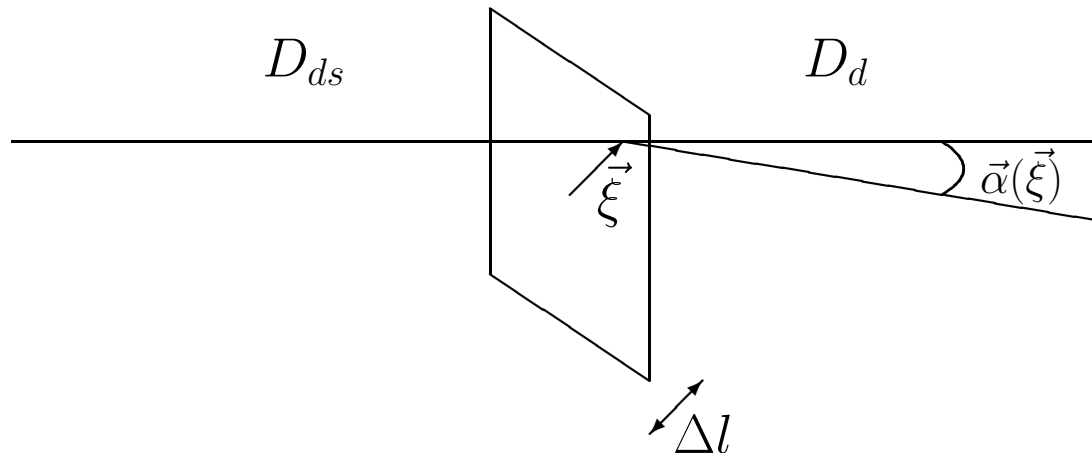

Therefore, the mass distribution of the lens can be treated as if it were an infinitely thin mass sheet perpendicular to the line-of-sight. The surface mass density is simply obtained by projection.

The plane of the mass sheet is called the **lens plane**. The mass sheet is characterized

by its surface mass density

$$\Sigma(\vec{\xi}) = \int_{\Delta l} \rho(\vec{\xi}, \vec{l}) dl$$

The deflection of a light ray passing the lens plane at  $\vec{\xi}$  by a mass element  $dm = \Sigma(\vec{\xi}') d^2\xi'$  at  $\vec{\xi}'$  is:

$$d\alpha = \frac{4Gdm}{c^2|\vec{\xi} - \vec{\xi}'|}$$

To get the deflection caused by all mass elements, we have to integrate over the whole surface. Doing this we must take into account that, e.g., the deflection caused by mass elements lying on opposite sides of the light ray may cancel out. Therefore we must add the deflection angles as vectors:

$$\vec{\alpha}(\vec{\xi}) = \frac{4G}{c^2} \int \frac{(\vec{\xi} - \vec{\xi}') \Sigma(\vec{\xi}')}{|\vec{\xi} - \vec{\xi}'|^2} d^2\xi'$$

**Special case:** For a spherical mass distribution the lensing problem can be reduced to one dimension. The deflection angle then points toward the center of symmetry and

we get:

$$\alpha(\xi) = \frac{4GM(< \xi)}{c^2\xi}$$

where  $\xi$  is the distance from the lens center and  $M(< \xi)$  is the mass enclosed within radius  $\xi$ ,

$$M(< \xi) = 2\pi \int_0^\xi \Sigma(\xi') \xi' d\xi'$$

## 11.2 Lensing Geometry and Lens Equation

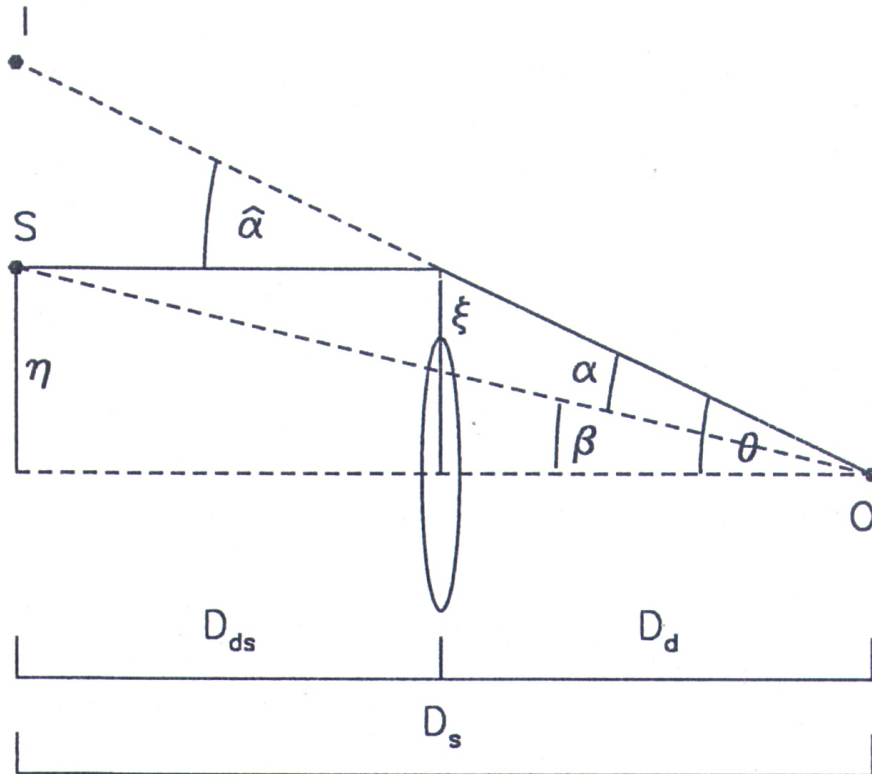

Important relations:

$$\hat{\alpha} \cdot D_{ds} = \alpha \cdot D_s \quad (11.1)$$

$$\theta \cdot D_s = \beta \cdot D_s + \hat{\alpha} \cdot D_{ds} \quad (11.2)$$

Note: The distances  $D$  are angular diameter distances.

Using relation 11.1 and 11.2 one obtains the so called lens equation:

$$\boxed{\beta = \theta - \alpha = \theta - \frac{D_{ds}}{D_s} \hat{\alpha}} \quad (11.3)$$

The lens equation relates the real position (angle) of the source (without a lens) with the position of the lensed image.

Important note: only angular distances are needed for deriving the lens equation. In general, i.e. over cosmological distances:  $D_{ds} \neq D_s - D_d$ .

## 11.3 Einstein radius and critical surface density

Consider now a circularly symmetric lens with an arbitrary mass profile. Due to the rotational symmetry of the lens system, a source, which lies exactly on the optical axis ( $\theta = \alpha \Leftrightarrow \beta = 0$ ) is imaged as a ring. This ring is the so called **Einstein ring**:

$$\beta = 0 \quad \rightsquigarrow \quad \theta = \alpha \tag{11.4}$$

$$= \frac{D_{ds}}{D_s} \cdot \hat{\alpha} \tag{11.5}$$

$$= \frac{D_{ds}}{D_s} \cdot \frac{4G}{c^2} \cdot \frac{M(< \xi)}{\xi} \tag{11.6}$$

$$= \frac{D_{ds}}{D_s} \cdot \frac{4\pi G}{c^2} \cdot \frac{M(< \xi)}{\pi \xi^2} \xi \tag{11.7}$$

$$= \frac{D_{ds}}{D_s} \cdot \frac{4\pi G}{c^2} \cdot \Sigma_{cr} \cdot D_d \cdot \theta \tag{11.8}$$

Therefore the **critical surface density** to observe an Einstein ring is:



$$\Sigma_{cr} = \frac{c^2}{4\pi G} \cdot \frac{D_s}{D_{ds}D_d} = 0.35 \frac{g}{cm^2} \frac{D_s \cdot 1Gpc}{D_{ds} \cdot D_d} \quad \text{critical surface density}$$

Note: The critical surface density depends only on the angular distances between source, lens and observer.

The radius of the Einstein ring can be calculated using formula (11.6) and  $\xi = D_d\theta$ :

$$\theta_E^2 = \frac{D_{ds}}{D_s D_d} \cdot \frac{4G}{c^2} \cdot M_{<\theta_E} \quad \text{Einstein radius}$$

where  $M_{<\theta_E}$  is the projected mass within  $\theta_E$ .

If the surface mass density has the value  $\Sigma_{cr}$  and is constant in  $\xi$ , we get a ideal convex lens. All light rays would then be focused in the point of observation:

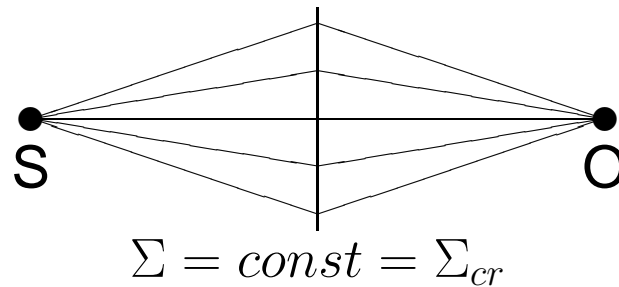

For a typical gravitational lens  $\Sigma$  decreases as a function of the radius.

Therefore only at a certain radius the condition for a circular image is fulfilled:

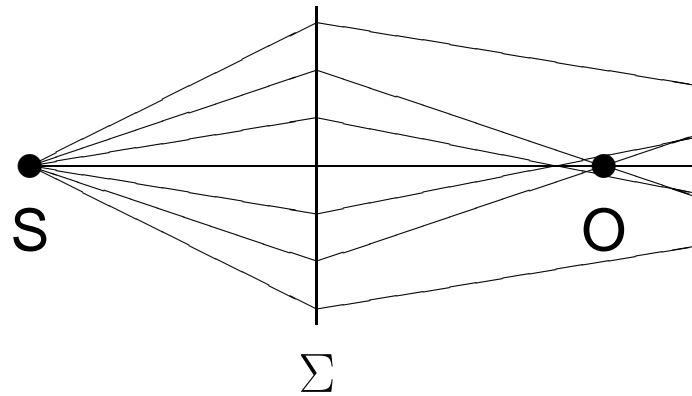

Furthermore gravitational lenses are hardly ever spherically symmetric. For an elliptical mass distribution one observes only parts of the ring, the so called *arcs*.

## Examples of Einstein angles $\theta_E$

### 1. Galaxy clusters:

typical mass:  $M \simeq 10^{14} M_\odot$

typical distances:  $\simeq 1 \text{ Gpc}$

This leads to:

$$\theta_E \simeq 10'' \left( \frac{M}{10^{13} M_\odot} \right)^{1/2} \left( \frac{D}{\text{Gpc}} \right)^{-1/2}$$

where  $D = \frac{D_s \cdot D_d}{D_{ds}}$ .

Thus for massive galaxy cluster ( $M > 10^{14} M_\odot$  within a few hundreds of kpc) we get observable angles in the order of ten arcsecs.

### 2. Stars (or similar objects) in the Milky Way:

$$\theta_E \simeq 0.001'' \left( \frac{M}{M_\odot} \right)^{1/2} \left( \frac{D}{10 \text{ kpc}} \right)^{-1/2}$$

Such a tiny angle cannot be directly observed, but sometimes it is possible to detect the amplification it causes.

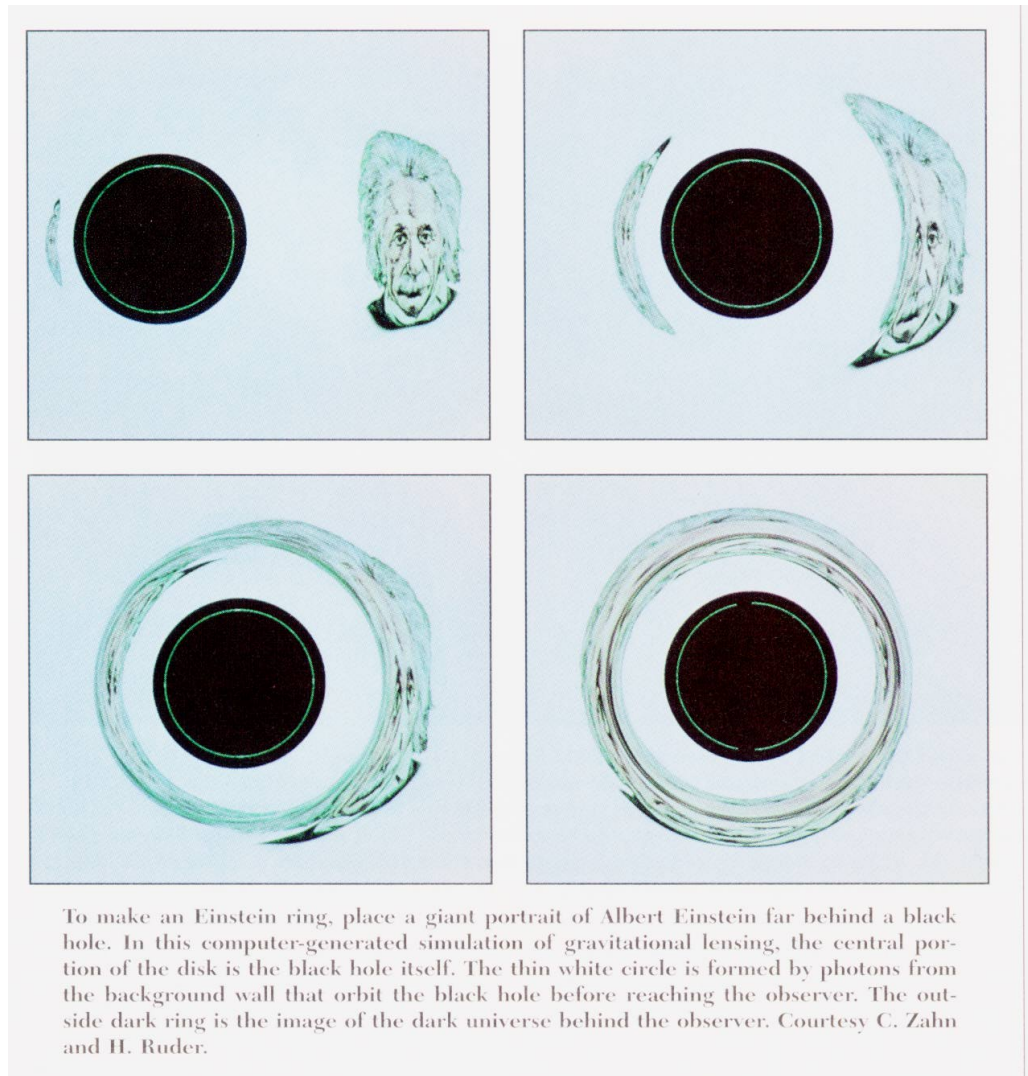

## 11.4 Magnification by a point mass lens

Rewriting equation (11.3):

$$\beta = \theta - \frac{D_{ds}}{D_s} \hat{\alpha} = \theta - \frac{D_{ds}}{D_s \cdot D_d} \cdot \frac{4GM}{c^2 \theta}$$

using the Einstein radius we get the following equations:

$$\beta = \theta - \frac{\theta_E^2}{\theta} \quad (11.9)$$

with the two solutions:

$$\theta_{\pm} = \frac{1}{2} \left( \beta \pm \sqrt{\beta^2 + 4\theta_E^2} \right) \quad (\theta_{\pm} > \beta!) \quad (11.10)$$

Therefore every source is imaged twice by the point mass. One image lies inside, the other outside the Einstein radius.

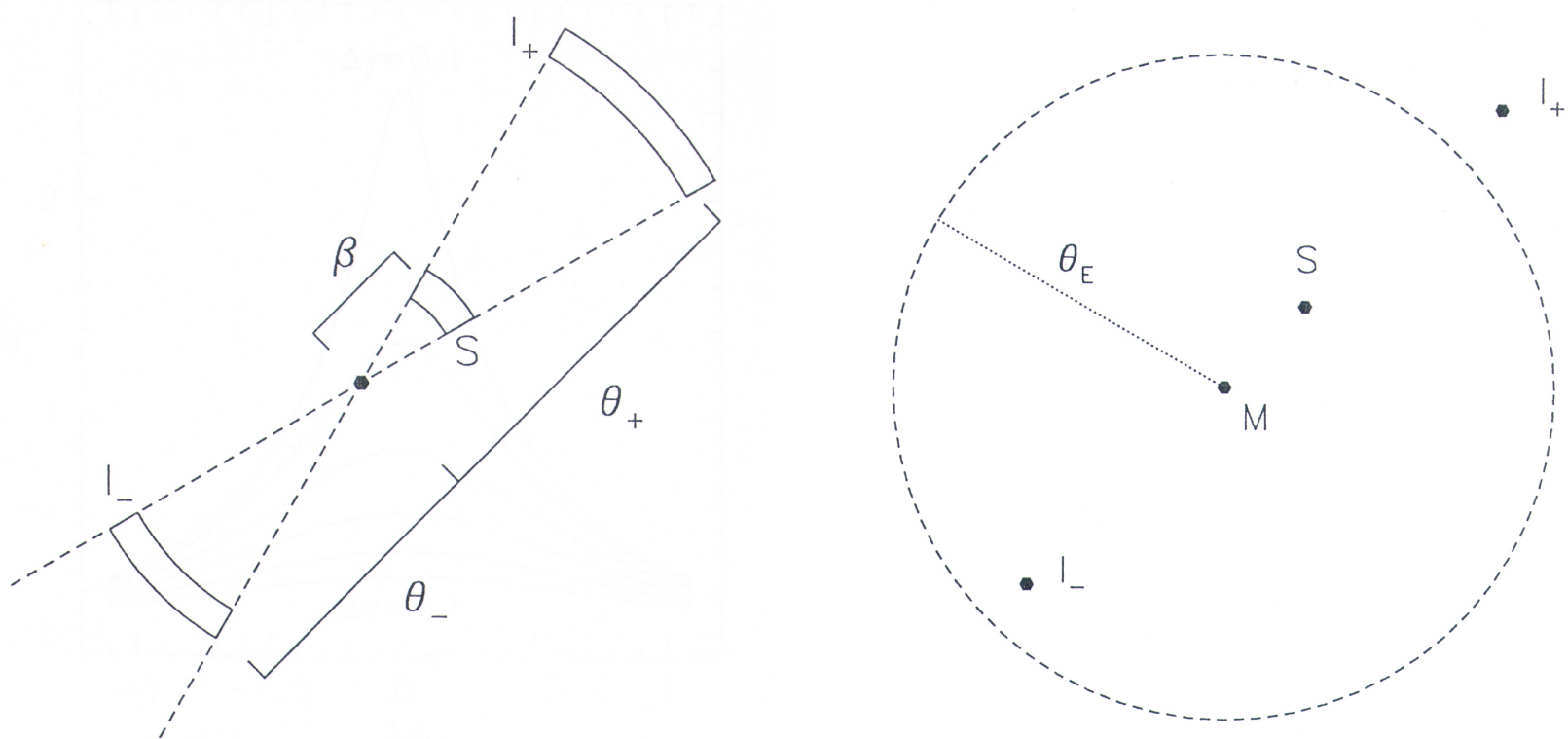

Gravitational light deflection preserves surface brightness (Liouville's theorem), but gravitational lensing changes the apparent solid angle of a source. The total flux received from a gravitationally lensed image of a source is therefore changed in proportion to the ratio between the solid angle of the image and the source.

For a circularly symmetric lens, the magnification factor is given by:

$$\mu = \frac{\theta}{\beta} \cdot \frac{d\theta}{d\beta}$$

For a point mass lens we can use equation (11.9) and (11.10) to obtain the magnification of the two images:

$$\mu_{\pm} = \left[ 1 - \left( \frac{\theta_E}{\theta_{\pm}} \right)^4 \right]^{-1} \quad (11.11)$$

It is clear from equation (11.11) that the magnification of the image inside the Einstein ring is negative. This means that this image has its parity flipped with respect to the source.

**N.B.:**  $\theta_{\pm} \rightarrow \theta_E \Rightarrow \mu \rightarrow 0$

## 11.5 Effective Lensing Potential

Let us define a scalar potential  $\psi(\vec{\theta})$  which is the appropriately scaled, projected Newtonian potential of the lens.

$$\psi(\vec{\theta}) = \frac{D_{ds}}{D_d D_s} \frac{2}{c^2} \int \Phi(D_d \vec{\theta}, z) dz \quad (11.12)$$

The gradient of  $\psi$  with respect to  $\theta$  is the deflection angle:

$$\vec{\nabla}_{\theta} \psi = D_d \vec{\nabla}_{\xi} \psi = \frac{D_{ds}}{D_s} \frac{2}{c^2} \int \overbrace{\vec{\nabla}_{\perp} \Phi}^{\vec{\alpha}} dz = \vec{\alpha} \quad (11.13)$$

with

$$\vec{\nabla}_{\perp} \Phi = \vec{\nabla}_{\xi} \Phi(\xi, z) = \frac{1}{D_d} \vec{\nabla}_{\theta} \Phi(D_d \theta, z) \quad (11.14)$$

while the Laplacian is proportional to the surface mass density  $\Sigma$



$$\vec{\nabla}_{\theta}^2 \psi = \frac{2 D_{ds} D_d}{c^2 D_s} \int \vec{\nabla}_{\xi}^2 \Phi dz = \frac{2 D_{ds} D_d}{c^2 D_s} \int \left( \vec{\nabla}^2 - \frac{\partial^2}{\partial z^2} \right) \Phi dz \quad (11.15)$$

$(\int_{-\infty}^{+\infty} \frac{\partial^2}{\partial z^2} \Phi dz = \frac{\partial \Phi}{\partial z} \Big|_{-\infty}^{+\infty} = 0, \text{ (the mass distribution is confined in a finite volume)})$

Therefore using  $\vec{\nabla}^2 \Phi = 4\pi G \rho$ :

$$\vec{\nabla}_{\theta}^2 \psi = \frac{2 D_{ds} D_d}{c^2 D_s} \int 4\pi G \rho dz = \frac{8\pi G D_{ds} D_d}{c^2 D_s} \Sigma(\xi) \quad (11.16)$$

Furthermore using  $\Sigma_{cr} = \frac{c^2}{4\pi G} \cdot \frac{D_s}{D_{ds} D_d}$  yields:

$$\boxed{\vec{\nabla}_{\theta}^2 \psi = 2 \frac{\Sigma(\vec{\theta})}{\Sigma_{cr}} := 2\kappa(\theta)} \quad (11.17)$$

The surface mass density scaled by its critical value is called the **convergence**  $\kappa(\theta)$ .

Since  $\psi$  satisfies the two dimensional Poisson equation  $\nabla_{\vec{\theta}}^2 \psi = 2\kappa$ , the effective lensing potential can be written in terms of  $\kappa$ :

$$\boxed{\psi(\vec{\theta}) = \frac{1}{\pi} \int \kappa(\theta') \ln |\vec{\theta} - \vec{\theta}'| d^2\theta'} \quad (11.18)$$

The local properties of the lens mapping are described by its Jacobian matrix  $A$ :

$$A = \frac{\partial \vec{\beta}}{\partial \vec{\theta}} \stackrel{(11.3)}{=} \frac{\partial}{\partial \vec{\theta}} (\vec{\theta} - \vec{\alpha}(\vec{\theta})) = \left[ \delta_{ij} - \frac{\partial \alpha_i}{\partial \theta_j} \right] \quad (11.19)$$

Using furthermore  $\alpha_i = \frac{\partial}{\partial \theta_i} \psi$  we get:

$$\boxed{A = \left( \delta_{ij} - \frac{\partial^2 \psi(\vec{\theta})}{\partial \theta_i \partial \theta_j} \right)} \quad \text{Jacobian matrix} \quad (11.20)$$

The local solid-angle distortion due to the lens is given by the determinant of  $A$ . A solid angle  $\delta\beta^2$  of the source is mapped to the solid-angle element  $\delta\theta^2$ , and so the

magnification is given by:

$$\boxed{\frac{\delta\theta^2}{\delta\beta^2} = \frac{1}{\det A} = \det M} \quad (11.21)$$

with the magnification tensor  $M$ .

Equation (11.20) shows that the matrix of second partial derivatives of the potential  $\psi$  (the Hessian matrix of  $\psi$ ) describes the deviation of the lens mapping from the identity mapping. For convenience, we introduce the abbreviation:

$$\frac{\partial^2\psi(\vec{\theta})}{\partial\theta_i\partial\theta_j} \equiv \psi_{ij}$$

Since the Laplacian of  $\psi$  is twice the convergence (see equation(11.17)) we have

$$\kappa = \frac{1}{2}(\psi_{11} + \psi_{22}) = \frac{1}{2} \text{tr } \psi_{ij} \quad (11.22)$$

Two additional linear combination of  $\psi_{ij}$  are important:

$$\gamma_1(\vec{\theta}) = \frac{1}{2}(\psi_{11} - \psi_{22}) \equiv \gamma(\vec{\theta}) \cos [2\Phi(\vec{\theta})] \quad (11.23)$$

$$\gamma_2(\vec{\theta}) = \psi_{12} = \psi_{21} \equiv \gamma(\vec{\theta}) \sin [2\Phi(\vec{\theta})] \quad (11.24)$$

These components  $(\gamma_1(\vec{\theta}), \gamma_2(\vec{\theta}))$  are the components of the **shear tensor**.

With these definitions, the Jacobian matrix can be written as:

$$A = \overbrace{(1 - \kappa) \begin{pmatrix} 1 & 0 \\ 0 & 1 \end{pmatrix}}^{\text{convergence}} - \overbrace{\begin{pmatrix} \gamma_1 & \gamma_2 \\ \gamma_2 & -\gamma_1 \end{pmatrix}}^{\text{shear}} = (1 - \kappa) \begin{pmatrix} 1 & 0 \\ 0 & 1 \end{pmatrix} - \gamma \begin{pmatrix} \cos(2\Phi) & \sin(2\Phi) \\ \sin(2\Phi) & -\cos(2\Phi) \end{pmatrix}$$

Convergence acting alone causes an isotropic focusing of light rays, leading to an isotropic magnification of a source. The image is mapped onto an image with the same shape but larger size. Shear introduces anisotropy (or astigmatism) into the lens mapping.

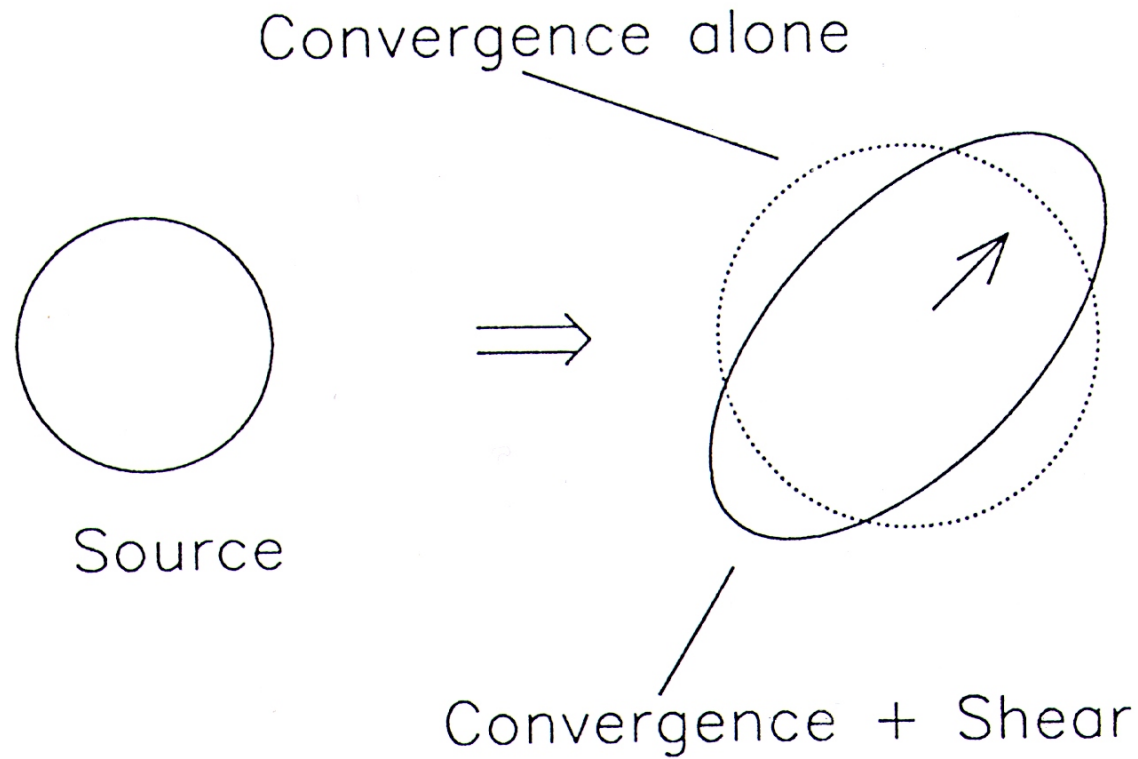
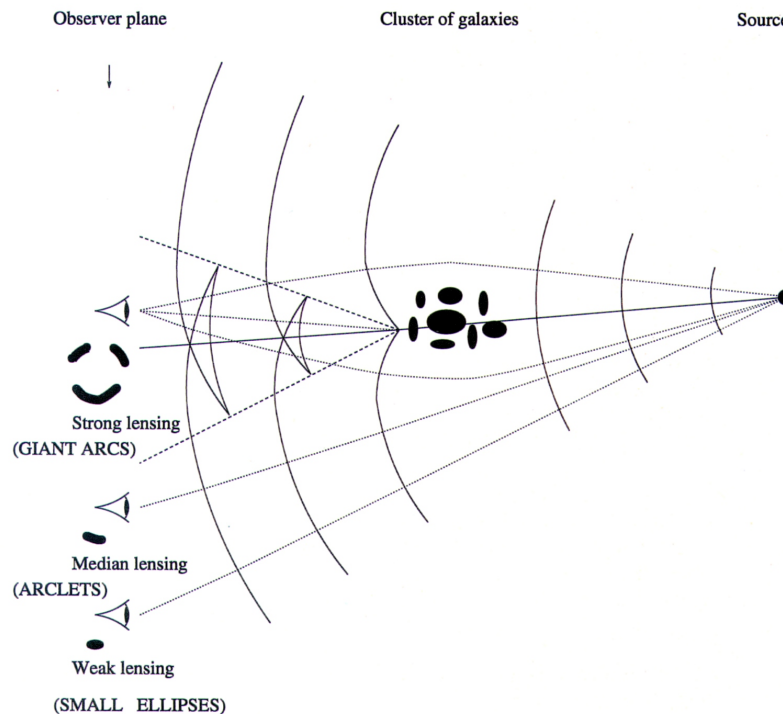

Illustration of the effects of convergence and shear of a circular source. Convergence magnifies the image isotropically and shear deforms it to an ellipse.



**Fig. 4.** Schematic view of the wavefronts in the presence of a cluster perturbation. The lens produces two effects. First, it deflects the light rays, and second it induces a pure gravitational time delay. Hence a deflected light ray which intersects the observer will arrive with a pure geometrical delay and a pure gravitational delay. Depending on the lens configuration, the observer will see multiple and strongly distorted images (arcs), single distorted images with elliptical shape (arclets), or weakly distorted images (weak shear regime) with individual elongation almost invisible. But each lensing regime has its own interest: strong lensing is rare but gives strong local constraints on the potential. Weak lensing is often difficult to quantify, but will occur in every cluster of galaxies. (—) Wavefront, (· · ·) optical ray, (- - -) strong lensing frontier

from Fort et al. (1994) *ARAA*, **5**, 239

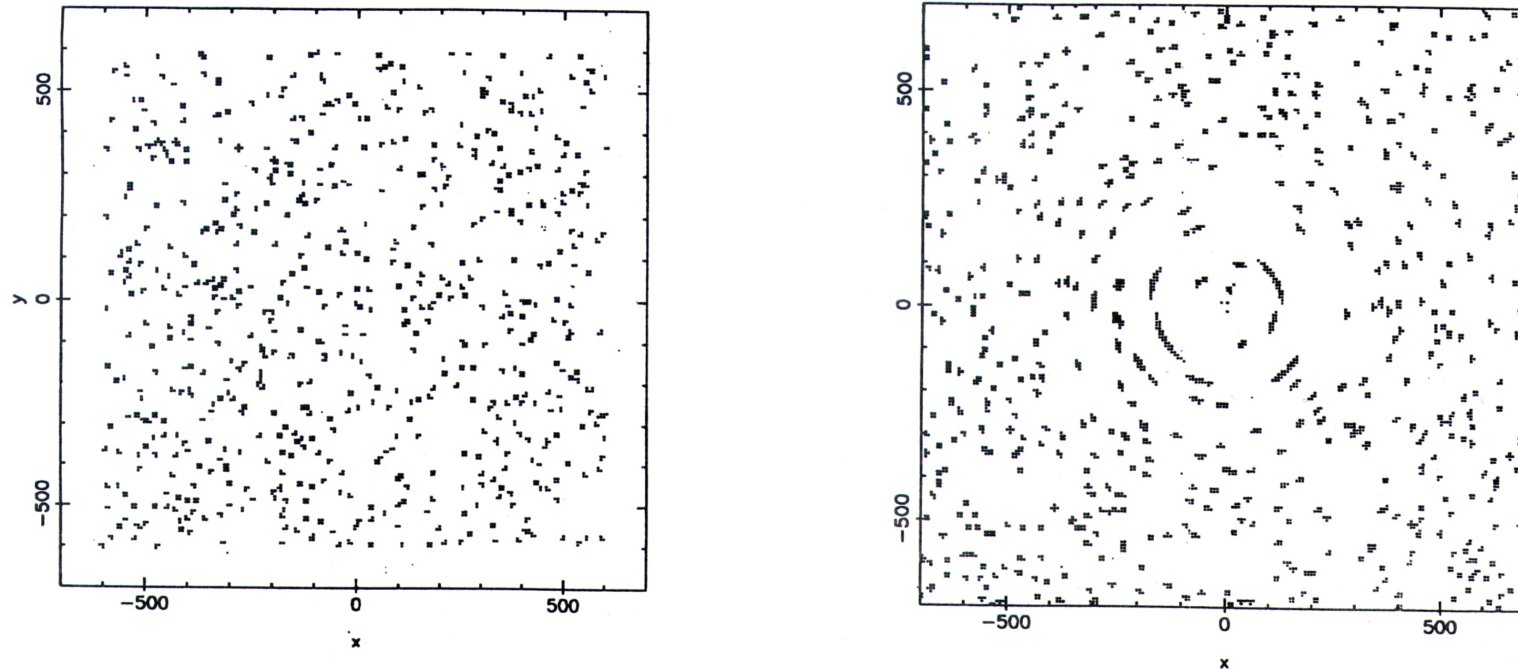

Fig. 5. Distortion field generated by a lens. The left panel shows the grid of randomly distributed background sources as it would be seen in the absence of the lens. The projected number density corresponds to the Tyson population at a limiting magnitude  $B = 28$  (Tyson 1988). The right panel shows the same population once they are distorted by a foreground (invisible) circular cluster with a typical velocity dispersion of  $1000 \text{ km s}^{-1}$ . The geometrical signature of the cluster is clearly visible. The potential can be recovered by using the formalism defined in part 4. In this simulation, the sources are at  $z = 1.3$ , and the cluster at  $z = 0.4$ .

see: Fort et al. (1994) *ARAA*, **5**, 239

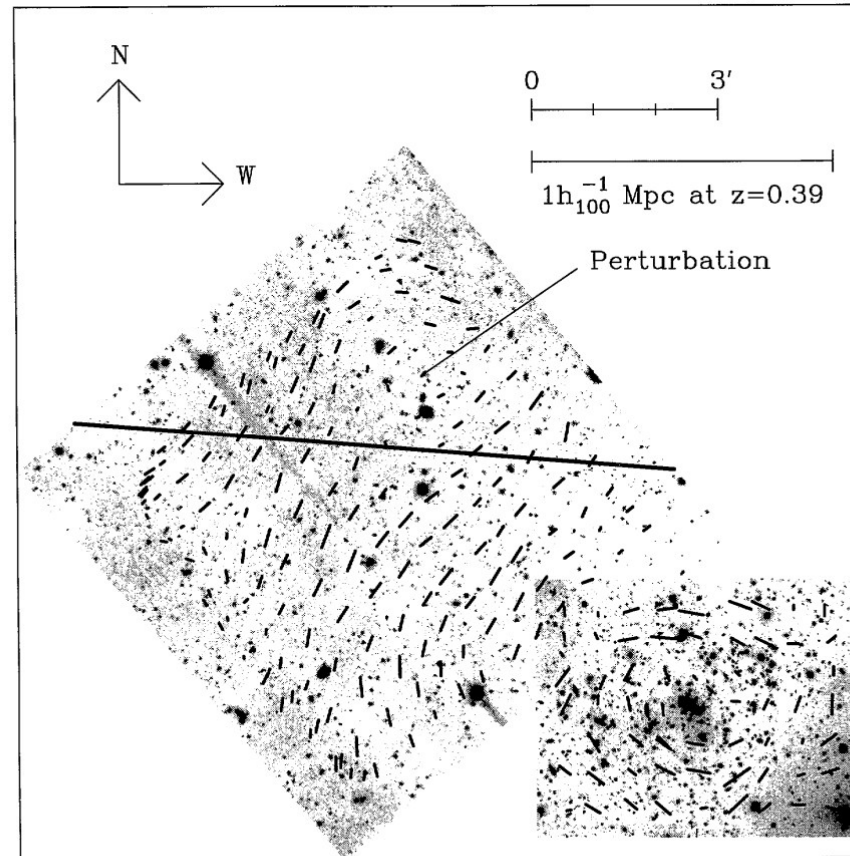
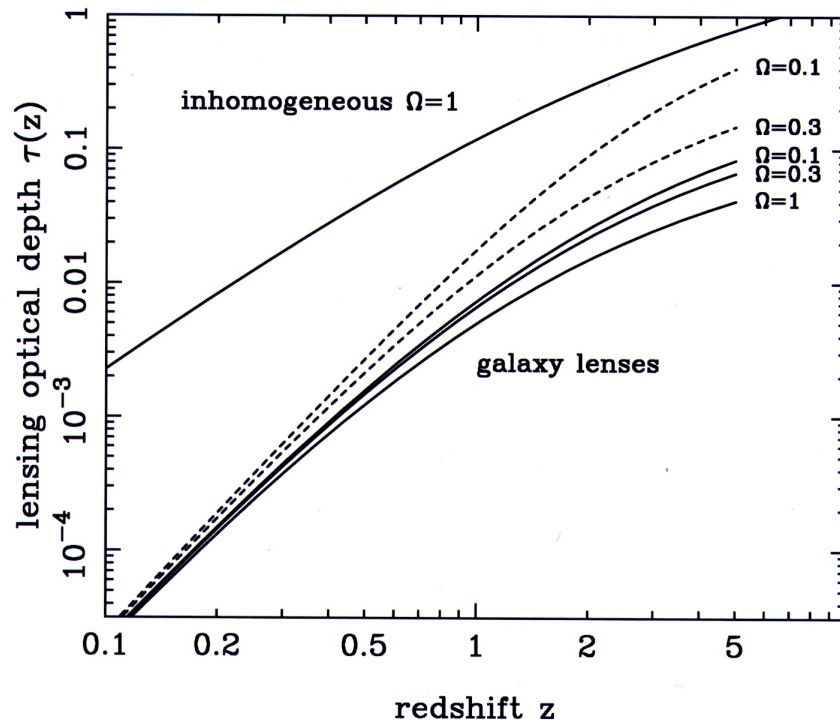

FIG. 1.—Shear pattern in Cl 0024. The  $B$  central field is at the bottom-right; black segments show the local orientation of the shear, and their length is proportional to the shear intensity (arbitrary scales for each field). A large perturbation to the cluster potential, associated with a local substructure, can be seen in the eastern field. This region, north of the horizontal line, was discarded for the measure of the radial evolution of the shear.

BONNET, MELLIER, & FORT (see 427, L84)

## Observation of weak shear, Bonnet et al. (1994) *ApJ*, 427, 83





**Figure 4.3.** The optical depth to gravitational lensing,  $\tau$ , in various models. The lower set of curves deals with gravitational lensing by the observed galaxy population only; results are shown for zero vacuum energy with  $\Omega = 1, 0.3$ , and  $0.1$  (solid lines) and flat vacuum-dominated models with  $\Omega = 0.3$  and  $0.1$  (broken lines). By contrast, the upper solid line shows a totally inhomogeneous universe (all dark matter as point-mass lenses) with  $\Omega = 1$ . For universes containing a smaller fraction of point-mass lenses, the optical depth scales as  $\tau \propto \Omega_m$ , with non-zero  $\Lambda$  having a similar relative effect on  $\tau$  as in the case of galaxy lensing. The increased lensing probability for  $\Lambda$ -dominated models is potentially an important signature of vacuum energy.

see: Peacock J.A.: Cosmological Physics, Cambridge University Press 1999